

Bin B3

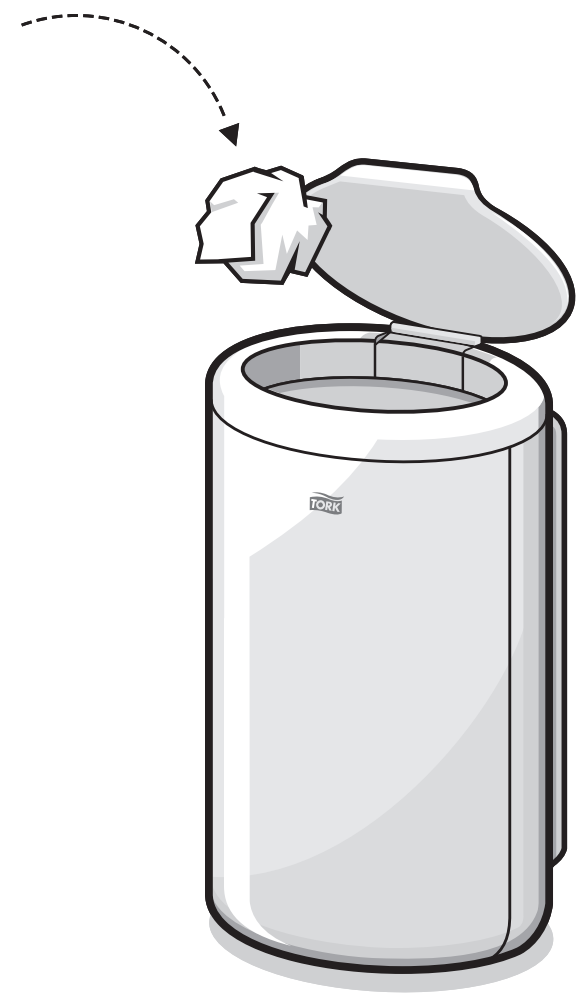

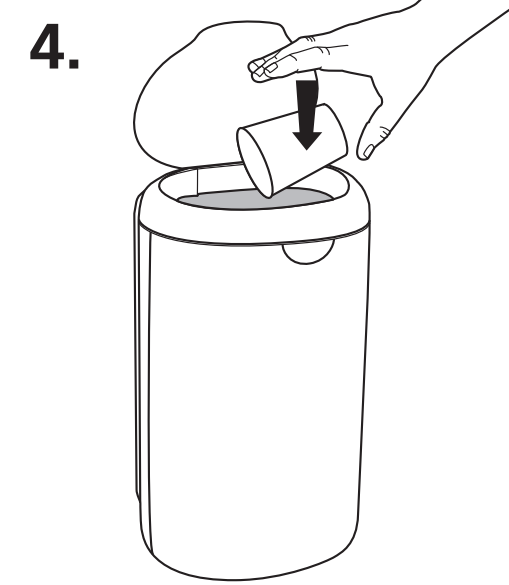

1.

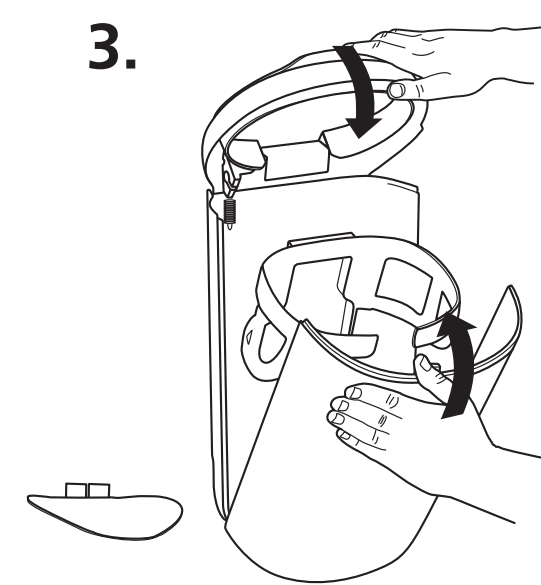
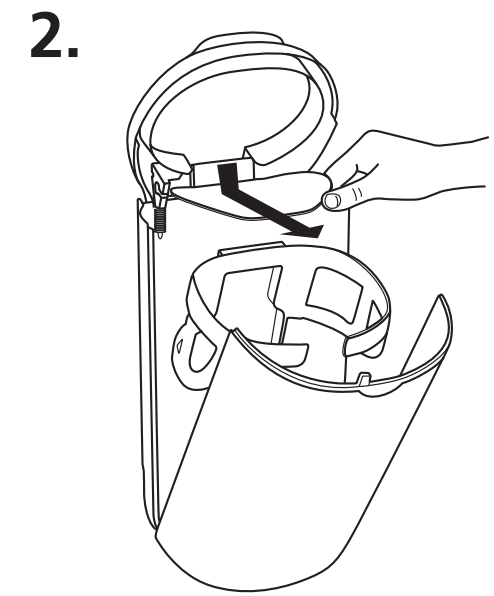
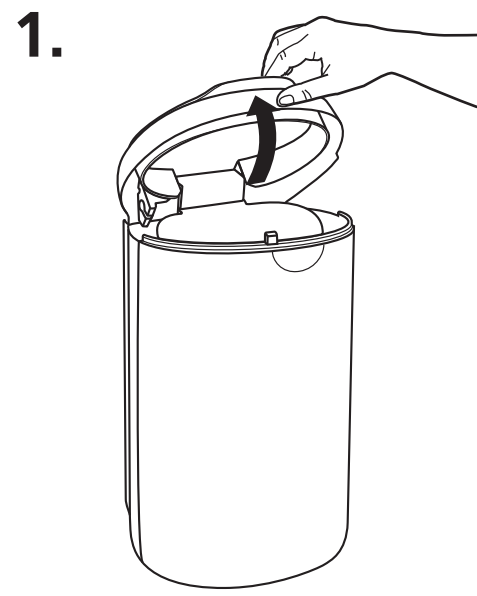
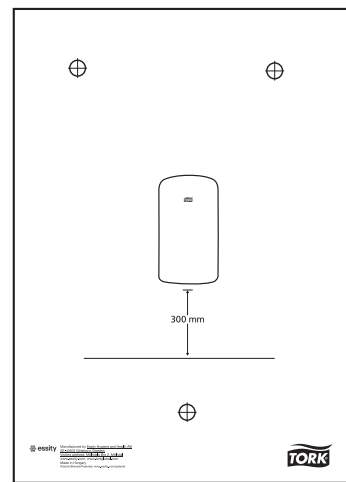
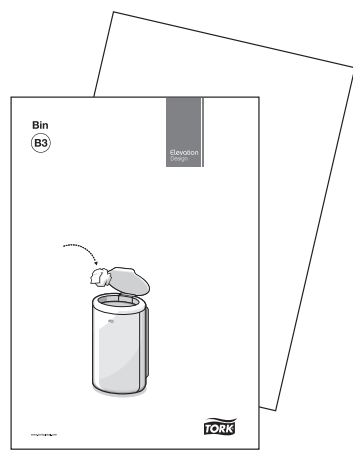
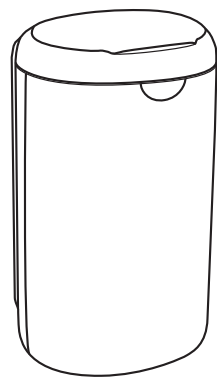
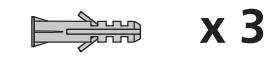
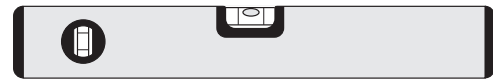
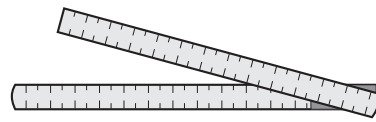
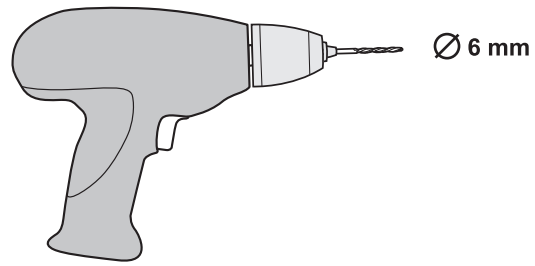
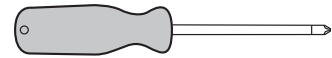
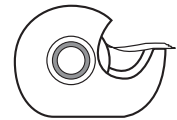
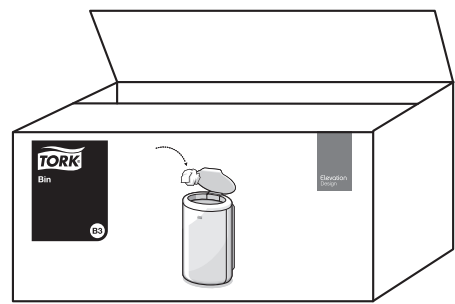
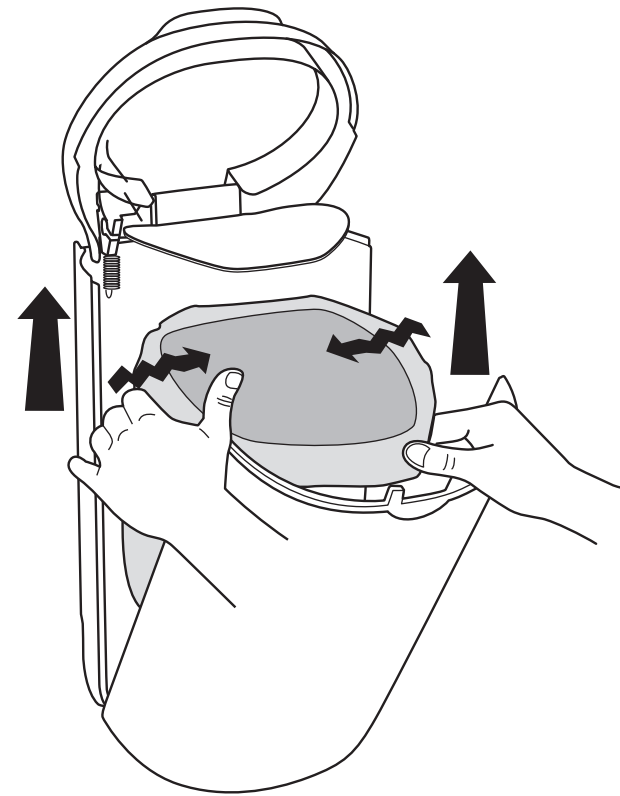

2.

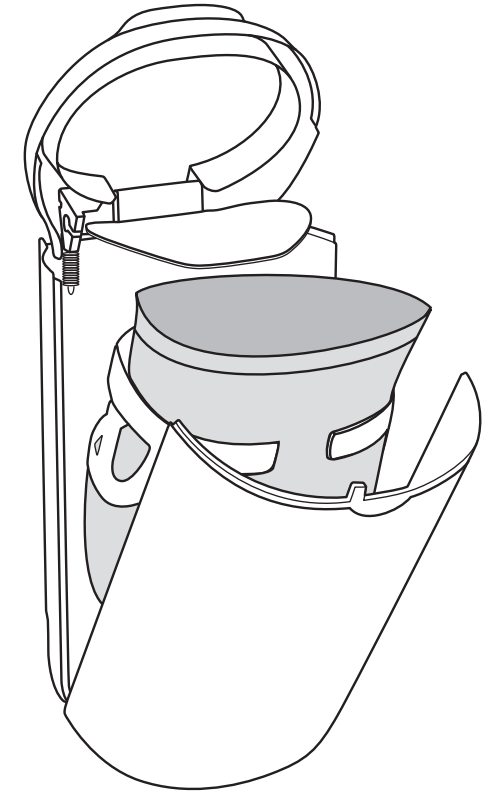

3.

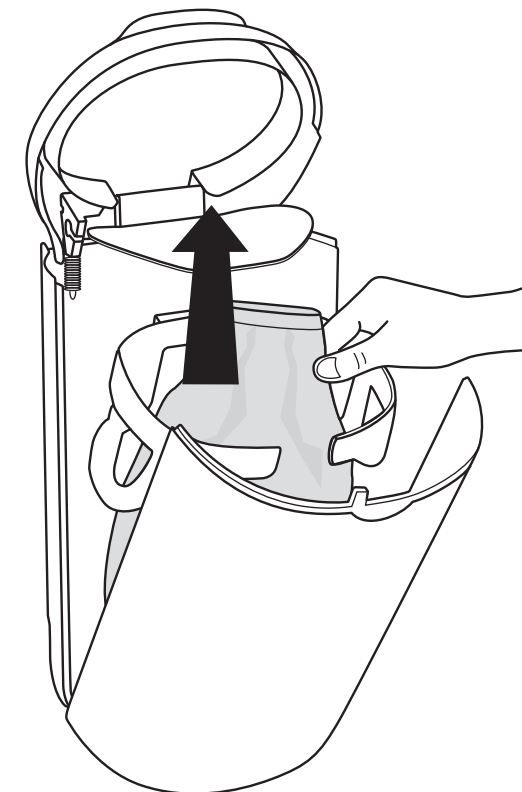

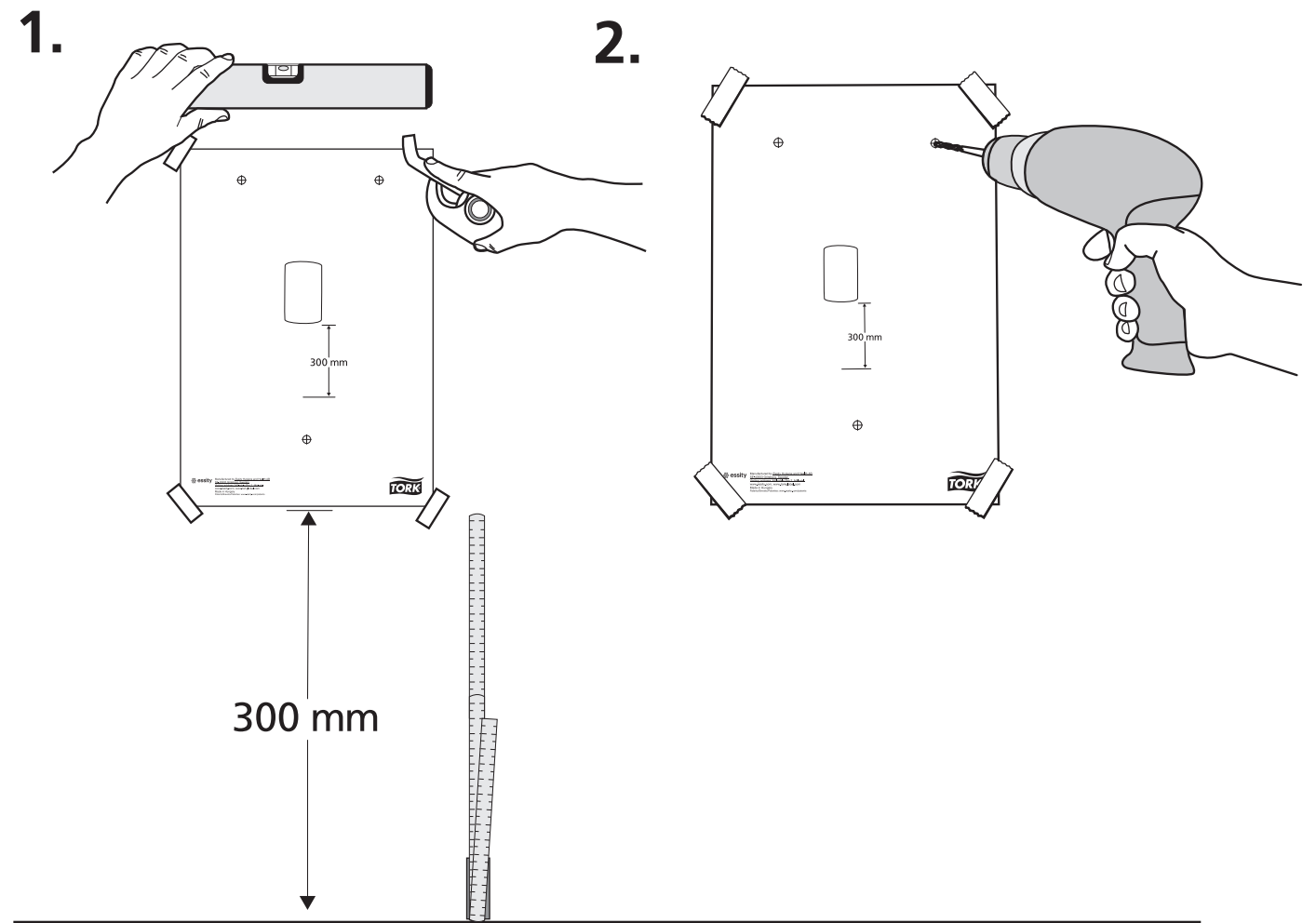

 x 3  x 3

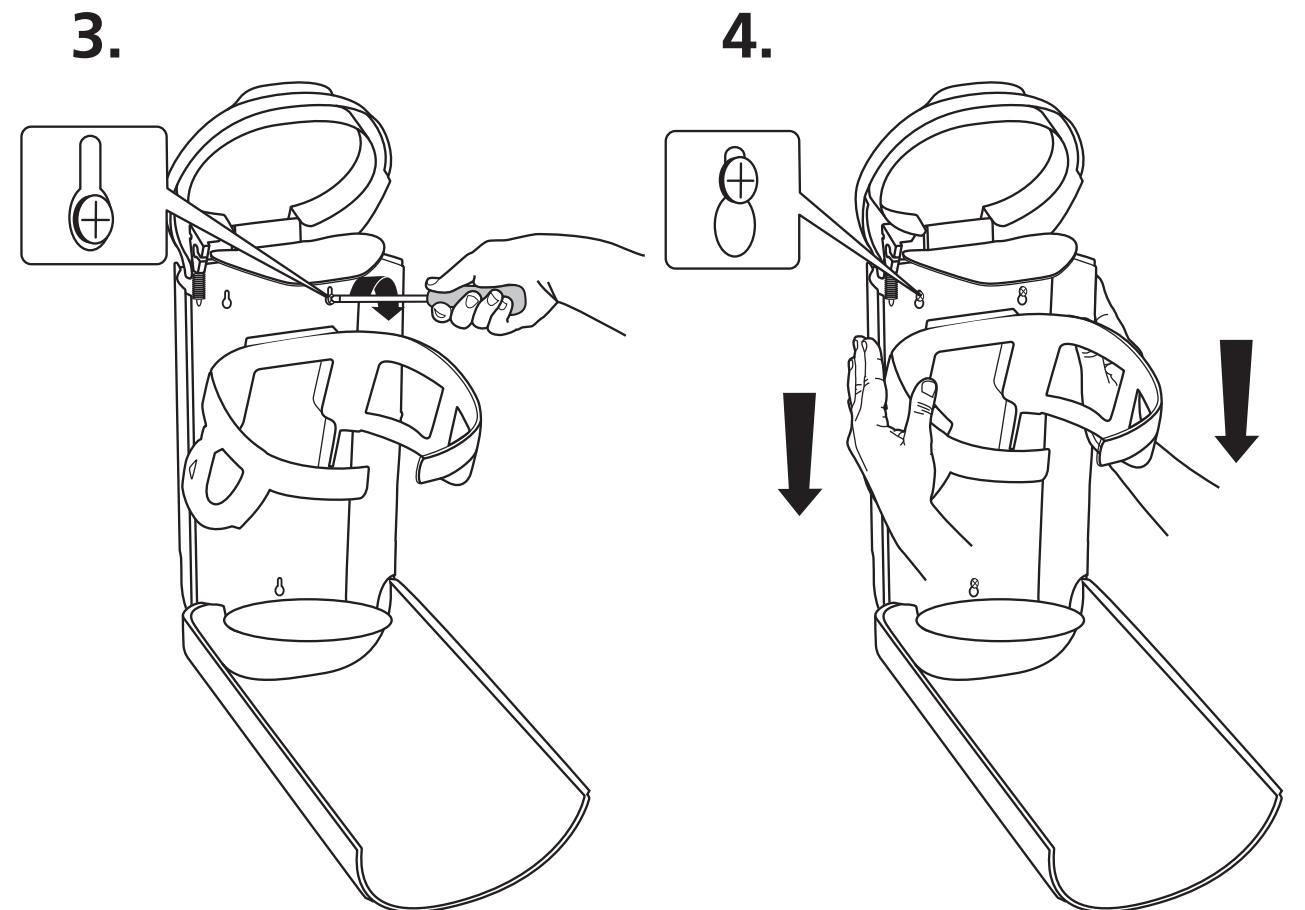

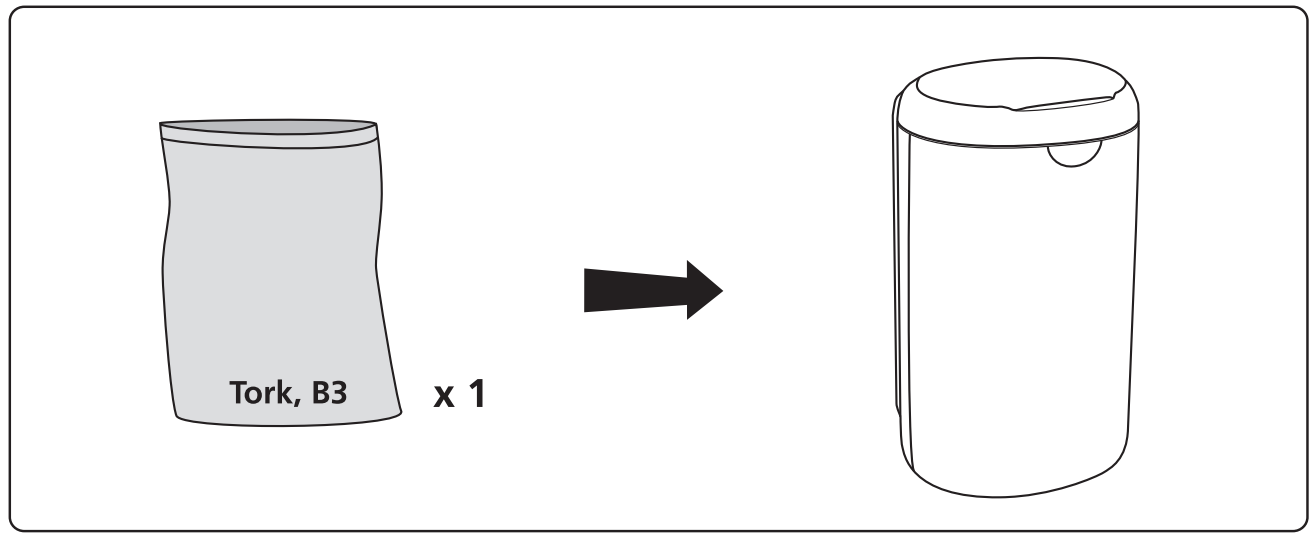

1.

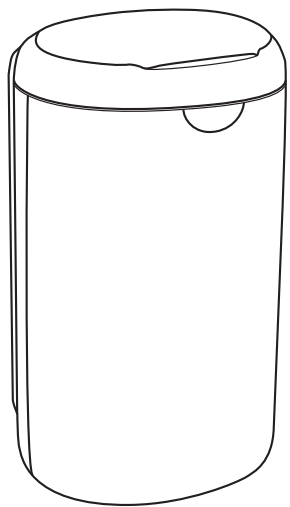

2.

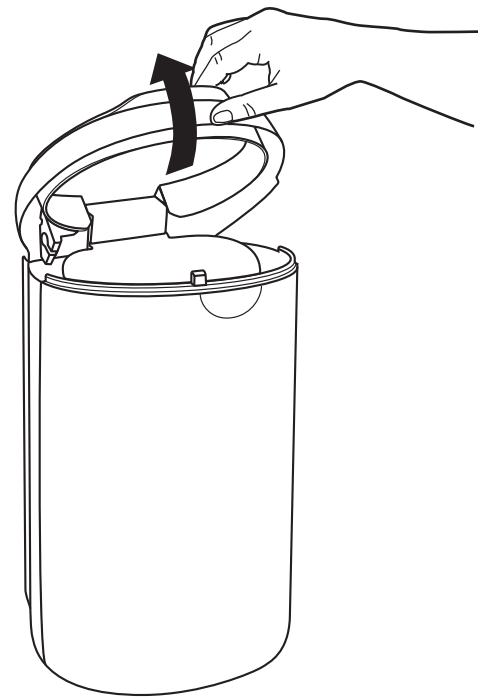

3.

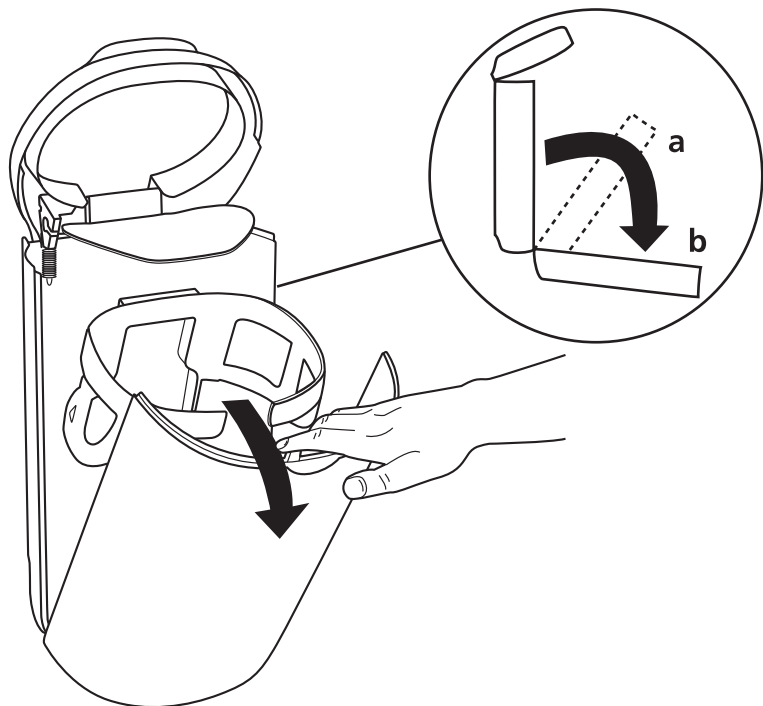

4.

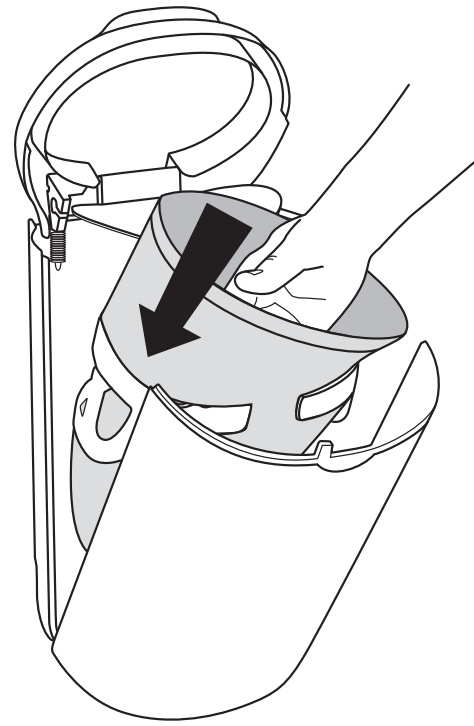

5.

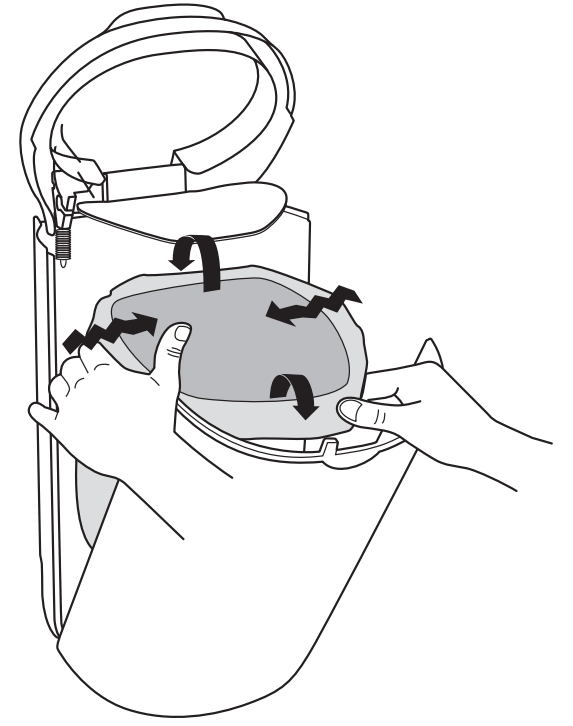

6.

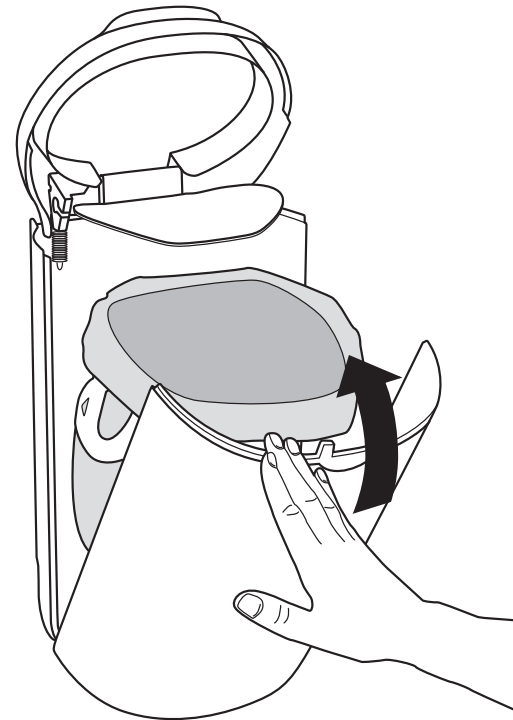

7.

